



REPLACEMENT SPRING INFORMATION

EZ-SET® TORSION SPRINGS



STANDARD TORSION SPRINGS



EXTENSION SPRINGS



IMPROPER INSTALLATION OR DOOR POSITION CAN RESULT IN SERIOUS INJURY OR DEATH. READ AND UNDERSTAND ALL INSTRUCTIONS BEFORE YOU BEGIN WORK. Wear safety goggles. Unplug power door operator and remove the opener travel arm from the door **FIRST**. Do not remove more than one part at a time. Do not attempt to raise or lower the door without all components installed securely. This hardware is intended for residential garage doors only. Springs and attached hardware are under extreme tension at all times. All tension must be released **SAFELY** from the springs before any work is performed on the springs, door sections or hardware. If you do not completely understand the installation instructions or are unsure if the replacement component matches the part being replaced – contact a professional installer.

TORSION SPRINGS CAN BE VERY DANGEROUS IF THEY ARE IMPROPERLY INSTALLED OR MISHANDLED. DO NOT attempt to install them yourself unless, 1) you have the proper tools and reasonable mechanical aptitude or experience, and 2) you follow enclosed instructions very carefully. Professional installation is recommended.

HOW TO SELECT YOUR SPRING

OPTION

1

By Measuring Dimension of Old Spring

Note: Not applicable for extension springs.

This information can be found on the respective EZ-SET® and standard torsion spring pages.

Figure Wire Diameter

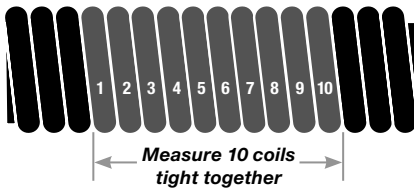

Measure Inside Diameter

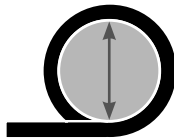

Measure Coil Length

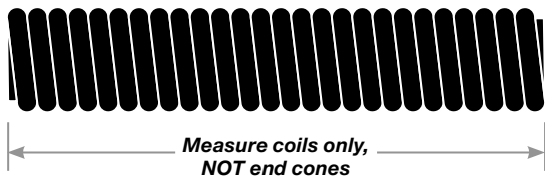

Determine Wind Direction

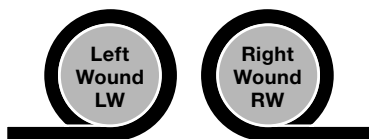

Looking at the spring end straight-on

OPTION

2

By Height and Weight of Door

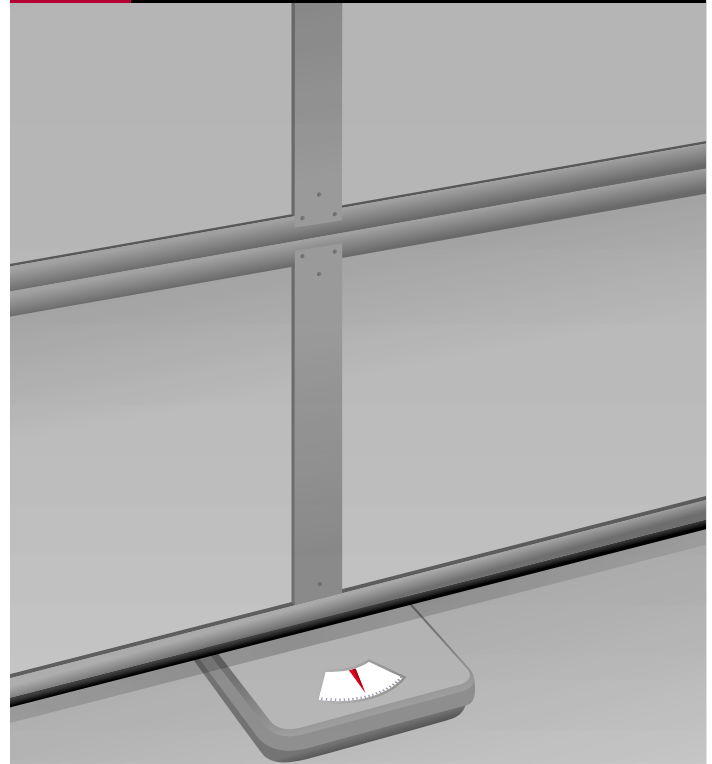

Weigh Unsprung Door with a Common Bathroom Scale(s)

Be sure spring tension has been released. See pages 9–11 for spring removal.

Two people or more will be required to raise the door to allow the placement of a bathroom scale(s) under the center of the door. Make sure to bend at the knees when lifting door and feet are clear of door travel.

For doors weighing more than one scale registers, two scales may be used by adding totals together.

FREQUENTLY ASKED QUESTIONS

OPTION

3

By Model and Size of Door



If it is a Holmes Garage Door and the model number is known, then use the grid shown on the spring-specific pages.

IMPORTANT NOTE: Left and Right Torsion Springs *May Not Match*

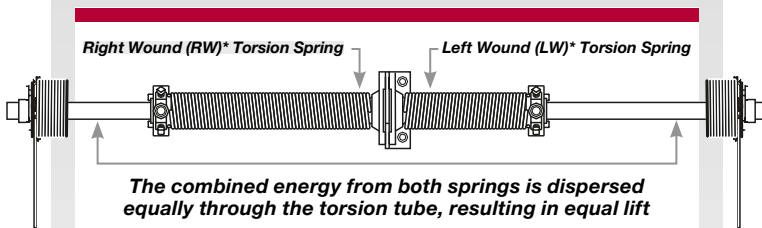

The combined energy from both springs is dispersed equally through the torsion tube, resulting in equal lift

Illustration pictured inside garage looking out

EZ-SET® torsion and standard torsion systems use a torsion tube that disperses equal lifting power to both sides evenly. The energy from the wound spring(s) is combined and transferred to the torsion tube. The torsion tube, however, doesn't know the length of the left or right springs, or if there are one or two springs (nor does it need to). It responds only to the amount of energy applied to the tube that, in turn, lifts both sides equally.

Many different combinations of springs are needed for the exact height and weight of every possible door. Therefore, it is only a coincidence if both sides have matching springs; it is more likely that *they wouldn't match*. Some doors may have only one spring.

**Standard track radius installation.*

Q: Should both springs be replaced if only one is broken?

A: Yes. If one spring broke, the other will likely break soon. The amount of work to replace two springs at the same time is a lot less than changing them out at different times.

Q: How important is it to be accurate when determining your replacement spring?

A: It is very important to be accurate. A garage door torsion spring system requires specific spring(s) based on the height and weight of the door. When the door is in the up position, it is important that the spring still has a couple of winds remaining. This ensures that the cables still have a small amount of tension, thus keeping them from falling off the drums. Plus, if your spring is too strong or too weak, it will be very hard to raise and lower the door.

Q: The door has only one torsion spring mounted. What lifts the other side of the door?

A: The energy from winding the spring is transferred to the torsion tube, which disperses equal lifting power to both sides.

Q: Do both springs on the right and left need to be the same?

A: Extension spring systems do need to have the same springs on both sides of the door, but this may not be the case for torsion springs. See the expanded explanation about torsion springs on this page ("**IMPORTANT NOTE: Left and Right Torsion Springs May Not Match**").

1

Select by Measuring Dimension of Old Spring

EZ-SET® TORSION SPRINGS

1

Figure Wire Diameter

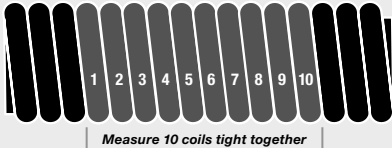

Measure 10 coils tight together

A. Measure 10 coils, write measurement using decimal.
Example: 1-15/16" would be 1.92".

B. Move decimal point one place to the left for wire diameter.
Example: 1.92" would be .192".

WIRE DIAMETER CONVERTER
Fractions are approximate

10 COILS	WIRE DIAM.	10 COILS	WIRE DIAM.
1-25/32"	= .177	2-1/4"	= .225
1-15/16"	= .192	2-11/32"	= .234
2-1/16"	= .207	2-7/16"	= .244
2-3/16"	= .219	2-1/2"	= .250

YOUR WIRE DIAMETER: _____

2

Measure Inside Diameter

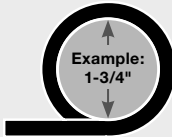

Example: 1-3/4"

YOUR INSIDE DIAMETER: _____

3

Measure Coil Length

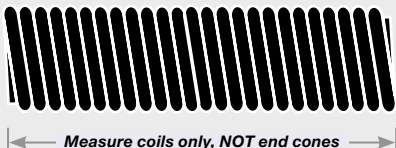

Measure coils only, NOT end cones
Example: 28"

YOUR COIL LENGTH: _____

4

Determine Wind Direction



Left Wound LW

Right Wound RW

YOUR WIND DIRECTION: _____

SPRING	1 WIRE DIAMETER	2 INSIDE DIAMETER	3 COIL LENGTH	4 WIND DIRECTION	
				LEFT WOUND PART NUMBER	RIGHT WOUND PART NUMBER
GOLD A	.177	1-3/4"	28"	(LW) 0145010	(RW) 0145020
GOLD B	.177	1-3/4"	32"	(LW) 0145030	(RW) 0145040
GOLD F	.177	1-3/4"	36"	(LW) 0145050	(RW) 0145060
ORANGE A	.192	1-3/4"	32"	(LW) 0145070	(RW) 0145080
ORANGE B	.192	1-3/4"	36"	(LW) 0145090	(RW) 0145100
ORANGE F	.192	1-3/4"	42"	(LW) 0145110	(RW) 0145120
YELLOW A	.207	1-3/4"	38"	(LW) 0145130	(RW) 0145140
YELLOW B	.207	1-3/4"	42"	(LW) 0145150	(RW) 0145160
YELLOW F	.207	1-3/4"	48"	(LW) 0145170	(RW) 0145180
WHITE A	.219	1-3/4"	42"	(LW) 0145190	(RW) 0145200
WHITE B	.219	1-3/4"	47"	(LW) 0145210	(RW) 0145220
WHITE F	.219	1-3/4"	55"	(LW) 0145230	(RW) 0145240
RED A	.225	1-3/4"	44"	(LW) 0145250	(RW) 0145260
RED B	.225	1-3/4"	50"	(LW) 0145270	(RW) 0145280
RED F	.225	1-3/4"	58"	(LW) 0145290	(RW) 0145300
BROWN A	.234	1-3/4"	47"	(LW) 0145310	(RW) 0145320
BROWN B	.234	1-3/4"	53"	(LW) 0145330	(RW) 0145340
BROWN F	.234	1-3/4"	62"	(LW) 0145350	(RW) 0145360
GREEN C	.244	1-3/4"	52"	(LW) 0145370	(RW) 0145380
GREEN D	.244	1-3/4"	58"	(LW) 0145390	(RW) 0145400
GREEN H	.244	1-3/4"	66"	(LW) 0145410	(RW) 0145420
GOLD C	.250	1-3/4"	54"	(LW) 0145430	(RW) 0145440
GOLD D	.250	1-3/4"	61"	(LW) 0145450	(RW) 0145460
GOLD H	.250	1-3/4"	71"	(LW) 0145470	(RW) 0145480

EZ-SET® torsion springs are special order parts for our retailers.

Important Note: If replacing one spring, replace ALL springs on the door.

INDUSTRY STANDARD COLOR CODES



EZ-SET® TORSION SPRINGS

OPTION

2 Select by Height and Weight of Door

	SPRING (LEFT WOUND)	SPRING (RIGHT WOUND)	DOOR HEIGHT	DOOR WEIGHT (LBS.)*
7' TALL DOORS	GOLD F (LW)	—	7'	66 – 75
	GOLD B (LW)	—	7'	76 – 83
	GOLD A (LW)	—	7'	84 – 108
	ORANGE A (LW)	—	7'	109 – 133
	YELLOW A (LW)	—	7'	134 – 155
	WHITE A (LW)	—	7'	156 – 170
	RED A (LW)	—	7'	171 – 190
	BROWN A (LW)	—	7'	191 – 211
	GREEN C (LW)	—	7'	212 – 215
	GOLD A (LW)	ORANGE A (RW)	7'	196 – 218
	ORANGE A (LW)	ORANGE A (RW)	7'	219 – 243
	ORANGE A (LW)	YELLOW A (RW)	7'	244 – 267
	YELLOW A (LW)	YELLOW A (RW)	7'	268 – 289
	YELLOW A (LW)	WHITE A (RW)	7'	290 – 311
	WHITE A (LW)	WHITE A (RW)	7'	312 – 326
	WHITE A (LW)	RED A (RW)	7'	327 – 341
	RED A (LW)	RED A (RW)	7'	342 – 361
	RED A (LW)	BROWN A (RW)	7'	362 – 381
	BROWN A (LW)	BROWN A (RW)	7'	382 – 402
	BROWN A (LW)	GREEN C (RW)	7'	403 – 424
GREEN C (LW)	GREEN C (RW)	7'	425 – 430	

8' TALL DOORS	GOLD F (LW)	—	8'	75 – 85
	GOLD B (LW)	—	8'	86 – 110
	ORANGE B (LW)	—	8'	111 – 134
	YELLOW B (LW)	—	8'	135 – 158
	WHITE B (LW)	—	8'	159 – 170
	RED B (LW)	—	8'	171 – 192
	BROWN B (LW)	—	8'	193 – 211
	GREEN D (LW)	—	8'	212 – 215
	GOLD B (LW)	ORANGE B (RW)	8'	216 – 223
	ORANGE B (LW)	ORANGE B (RW)	8'	224 – 246
	ORANGE B (LW)	YELLOW B (RW)	8'	247 – 269
	YELLOW B (LW)	YELLOW B (RW)	8'	270 – 293
	YELLOW B (LW)	WHITE B (RW)	8'	294 – 317
	WHITE B (LW)	WHITE B (RW)	8'	318 – 330
	WHITE B (LW)	RED B (RW)	8'	331 – 342
	RED B (LW)	RED B (RW)	8'	343 – 363
	RED B (LW)	BROWN B (RW)	8'	364 – 385
	BROWN B (LW)	BROWN B (RW)	8'	386 – 404
	BROWN B (LW)	GREEN D (RW)	8'	405 – 424
	GREEN D (LW)	GREEN D (RW)	8'	425 – 430

*Refer to page 2 for door weighing instructions.

OPTION

3 Select by Model and Size of Door

	SPRING (LEFT WOUND)	SPRING (RIGHT WOUND)	4200 BRONZE SERIES	5200 SILVER SERIES	6130 GOLD SERIES
7' TALL DOORS	GOLD A (LW)	—	8' x 7' 9' x 7'	8' x 7' 9' x 7'	8' x 7'
	ORANGE A (LW)	—			9' x 7'
	WHITE A (LW)	—	16' x 7'	16' x 7'	
	BROWN A (LW)	—			16' x 7'
8' TALL DOORS	ORANGE B (LW)	—		9' x 8'	
	YELLOW B (LW)	—			9' x 8'
	ORANGE B (LW)	ORANGE B (RW)			16' x 8'
	BROWN B (LW)	—		16' x 8'	

EZ-SET®
torsion springs
are special order parts
for our retailers.

Important Note
If replacing one spring,
replace ALL springs
on the door.

1

Select by Measuring Dimension of Old Spring

STANDARD TORSION SPRINGS

1

Figure Wire Diameter



Measure 10 coils tight together

- A. Measure 10 coils, write measurement using decimal.
Example: 2-1/4" would be .225".
- B. Move decimal point one place to the left for wire diameter.
Example: 2.25" would be .225".

WIRE DIAMETER CONVERTER

Fractions are approximate

10 COILS	WIRE DIAM.	10 COILS	WIRE DIAM.
1-15/16"	= .192	2-5/8"	= .262
2-1/16"	= .207	2-3/4"	= .275
2-3/16"	= .218	2-27/32"	= .283
2-1/4"	= .225	2-31/32"	= .295
2-11/32"	= .234	3-1/16"	= .306
2-7/16"	= .243	3-3/16"	= .319
2-1/2"	= .250		

YOUR WIRE DIAMETER: _____

2

Measure Inside Diameter

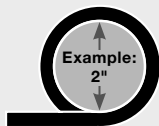

YOUR INSIDE DIAMETER: _____

3

Measure Coil Length

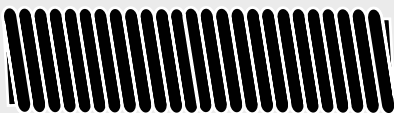

Measure coils only, NOT end cones
Example: 26"

YOUR COIL LENGTH: _____

4

Determine Wind Direction



YOUR WIND DIRECTION: _____

SPRING	WIRE DIAMETER	INSIDE DIAMETER	COIL LENGTH	WIND DIRECTION	
				LEFT WOUND PART NUMBER	RIGHT WOUND PART NUMBER
#1 ORANGE	.192	2"	16-1/2"	(LW) 7000151	(RW) 7000152
#2 ORANGE	.192	2"	18-1/2"	(LW) 7000153	(RW) 7000154
#3 ORANGE	.192	2"	20-1/2"	(LW) 7000155	(RW) 7000156
#10 ORANGE	.192	2"	22"	(LW) 7000241	(RW) 7000242
#11 ORANGE	.192	2"	24"	(LW) 7000243	(RW) 7000244
#12 ORANGE	.192	2"	26-1/2"	(LW) 7000112	(RW) 7000095
#1 YELLOW	.207	2"	19-1/2"	(LW) 7000157	(RW) 7000158
#2 YELLOW	.207	2"	21-1/2"	(LW) 7000159	(RW) 7000160
#3 YELLOW	.207	2"	24"	(LW) 7000161	(RW) 7000162
#4 YELLOW	.207	2"	26-1/2"	(LW) 7000163	(RW) 7000164
#5 YELLOW	.207	2"	31"	(LW) 7000113	(RW) 7000114
#1 WHITE	.218	2"	22"	(LW) 7000165	(RW) 7000166
#2 WHITE	.218	2"	24-1/2"	(LW) 7000167	(RW) 7000168
#3 WHITE	.218	2"	27"	(LW) 7000169	(RW) 7000170
#4 WHITE	.218	2"	29-1/2"	(LW) 7000171	(RW) 7000172
#10 WHITE	.218	2"	35"	(LW) 7000115	(RW) 7000116
#1 RED	.225	2"	23-1/2"	(LW) 7000173	(RW) 7000174
#2 RED	.225	2"	26"	(LW) 7000165	(RW) 7000176
#3 RED	.225	2"	29"	(LW) 7000177	(RW) 7000178
#4 RED	.225	2"	31-1/2"	(LW) 7000179	(RW) 7000180
#5 RED	.225	2"	37"	(LW) 7000117	(RW) 7000118
#1 BROWN	.234	2"	25"	(LW) 7000181	(RW) 7000182
#2 BROWN	.234	2"	28"	(LW) 7000183	(RW) 7000184
#3 BROWN	.234	2"	31"	(LW) 7000185	(RW) 7000186
#4 BROWN	.234	2"	34"	(LW) 7000187	(RW) 7000188
#7 BROWN	.234	2"	40"	(LW) 7000119	(RW) 7000120
#1 GREEN	.243	2"	27-1/2"	(LW) 7000189	(RW) 7000190
#2 GREEN	.243	2"	30-1/2"	(LW) 7000191	(RW) 7000192
#3 GREEN	.243	2"	34"	(LW) 7000193	(RW) 7000194
#4 GREEN	.243	2"	37"	(LW) 7000195	(RW) 7000196
#5 GREEN	.243	2"	43-1/2"	(LW) 7000096	(RW) 7000097
#1 GOLD	.250	2"	29"	(LW) 7000197	(RW) 7000198
#2 GOLD	.250	2"	32"	(LW) 7000199	(RW) 7000200
#3 GOLD	.250	2"	35-1/2"	(LW) 7000201	(RW) 7000202
#4 GOLD	.250	2"	39"	(LW) 7000203	(RW) 7000204
#5 GOLD	.250	2"	46"	(LW) 7000121	(RW) 7000122
#6 GOLD	.250	2.62"	36"	(LW) 7000129	(RW) 7000130
#1 BLUE	.262	2"	32"	(LW) 7000205	(RW) 7000206
#2 BLUE	.262	2"	35-1/2"	(LW) 7000207	(RW) 7000208
#3 BLUE	.262	2"	39"	(LW) 7000209	(RW) 7000210
#4 BLUE	.262	2"	43"	(LW) 7000211	(RW) 7000212
#5 BLUE	.262	2.62"	40"	(LW) 7000098	(RW) 7000099
#4 ORANGE	.273	2"	34-1/2"	(LW) 7000213	(RW) 7000214
#5 ORANGE	.273	2"	38"	(LW) 7000215	(RW) 7000216
#6 ORANGE	.273	2"	43"	(LW) 7000217	(RW) 7000218
#7 ORANGE	.273	2"	40"	(LW) 7000219	(RW) 7000220
#8 ORANGE	.273	2"	47"	(LW) 7000221	(RW) 7000222
#9 ORANGE	.273	2.62"	43-1/2"	(LW) 7000100	(RW) 7000101
#3 LT. BLUE	.283	2.62"	37"	(LW) 7000102	(RW) 7000103
#4 LT. BLUE	.283	2.62"	40"	(LW) 7000104	(RW) 7000105
#5 LT. BLUE	.283	2.62"	47"	(LW) 7000106	(RW) 7000107
#7 WHITE	.295	2.62"	40"	(LW) 7000123	(RW) 7000124
#8 WHITE	.295	2.62"	44"	(LW) 7000108	(RW) 7000109
#9 WHITE	.295	2.62"	51"	(LW) 7000125	(RW) 7000126
#8 BROWN	.306	2.62"	55"	(LW) 7000110	(RW) 7000111
#6 GREEN	.319	2.62"	40-1/2"	(LW) 7000127	(RW) 7000128

Torsion springs are special order parts for our retailers.

Important Note: If replacing one spring, replace ALL springs on the door.

INDUSTRY STANDARD COLOR CODES

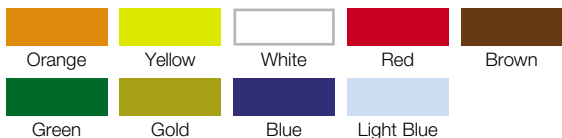

STANDARD TORSION SPRINGS

OPTION

2 Select by Height and Weight of Door

	SPRING (LEFT WOUND)	SPRING (RIGHT WOUND)	DOOR HEIGHT	DOOR WEIGHT (LBS.)*
7' TALL DOORS	#11 ORANGE (LW)	—	7'	52 – 56
	#10 ORANGE (LW)	—	7'	57 – 61
	#3 ORANGE (LW)	—	7'	62 – 68
	#2 ORANGE (LW)	—	7'	69 – 77
	#1 ORANGE (LW)	—	7'	78 – 84
	#2 YELLOW (LW)	—	7'	85 – 93
	#1 YELLOW (LW)	—	7'	94 – 105
	#2 RED (LW)	—	7'	106 – 108
	#1 WHITE (LW)	—	7'	109 – 118
	#1 RED (LW)	—	7'	119 – 132
	#1 BROWN (LW)	—	7'	133 – 146
	#1 GREEN (LW)	—	7'	147 – 157
	#1 GOLD (LW)	—	7'	158 – 162
	#2 BLUE (LW)	—	7'	163 – 170
	#1 YELLOW (LW)	#1 ORANGE (RW)	7'	171 – 185
	#1 WHITE (LW)	#1 ORANGE (RW)	7'	186 – 196
	#1 RED (LW)	#1 ORANGE (RW)	7'	197 – 202
	#1 YELLOW (LW)	#1 WHITE (RW)	7'	203 – 209
	#1 BROWN (LW)	#1 ORANGE (RW)	7'	210 – 216
	#1 WHITE (LW)	#1 WHITE (RW)	7'	217 – 227
	#1 RED (LW)	#1 WHITE (RW)	7'	228 – 241
	#1 BROWN (LW)	#1 WHITE (RW)	7'	242 – 251
	#1 RED (LW)	#1 BROWN (RW)	7'	252 – 255
	#1 GREEN (LW)	#1 WHITE (RW)	7'	256 – 265
	#1 BROWN (LW)	#1 BROWN (RW)	7'	266 – 276
	#1 RED (LW) B	#1 GOLD (RW)	7'	277 – 279
	#1 GREEN (LW)	#1 BROWN (RW)	7'	280 – 289
	#1 BROWN (LW)	#1 GOLD (RW)	7'	290 – 299
	#1 RED (LW) B	#1 BLUE (RW)	7'	300 – 304
	#1 GREEN (LW)	#1 GOLD (RW)	7'	305 – 314
	#1 GOLD (LW)	#1 GOLD (RW)	7'	315 – 327
	#1 GREEN (LW)	#1 BLUE (RW)	7'	328 – 337
	#1 GOLD (LW)	#1 BLUE (RW)	7'	338 – 349
	#1 GREEN (LW)	#4 ORANGE (RW)	7'	350 – 359
	#1 GOLD (LW)	#4 ORANGE (RW)	7'	360 – 383
	#1 BLUE (LW)	#4 ORANGE (RW)	7'	384 – 404
	#4 ORANGE (LW)	#4 ORANGE (RW)	7'	405 – 417
	#9 ORANGE (LW)	#6 GREEN (RW)	7'	418 – 429
	#5 LT. BLUE (LW)	#6 GREEN (RW)	7'	430 – 447
	#9 WHITE (LW)	#6 GREEN (RW)	7'	448 – 454
#4 LT. BLUE (LW)	#6 GREEN (RW)	7'	455 – 465	
#8 BROWN (LW)	#6 GREEN (RW)	7'	466 – 468	
#3 LT. BLUE (LW)	#6 GREEN (RW)	7'	469 – 472	

8' TALL DOORS	#11 ORANGE (LW)	—	8'	58 – 63
	#10 ORANGE (LW)	—	8'	64 – 68
	#3 ORANGE (LW)	—	8'	69 – 76
	#2 ORANGE (LW)	—	8'	77 – 84
	#3 YELLOW (LW)	—	8'	85 – 94
	#2 YELLOW (LW)	—	8'	95 – 97
	#3 WHITE (LW)	—	8'	98 – 108
	#2 WHITE (LW)	—	8'	109 – 117
	#2 RED (LW)	—	8'	118 – 131
	#2 BROWN (LW)	—	8'	132 – 142
	#3 GOLD (LW)	—	8'	143 – 146
	#2 GREEN (LW)	—	8'	147 – 158
	#2 GOLD (LW)	—	8'	159 – 163
	#3 BLUE (LW)	—	8'	164 – 170
	#2 YELLOW (LW)	#2 ORANGE (RW)	8'	171 – 184
	#2 WHITE (LW)	#2 ORANGE (RW)	8'	185 – 193
	#2 RED (LW)	#2 ORANGE (RW)	8'	194 – 202
	#2 WHITE (LW)	#2 YELLOW (RW)	8'	203 – 211
	#2 RED (LW)	#2 YELLOW (RW)	8'	212 – 216
	#2 WHITE (LW)	#2 WHITE (RW)	8'	217 – 225
	#2 BROWN (LW)	#2 YELLOW (RW)	8'	226 – 234
	#2 RED (LW)	#2 RED (RW)	8'	235 – 239
	#2 BROWN (LW)	#2 WHITE (RW)	8'	240 – 248
	#2 BROWN (LW)	#2 RED (RW)	8'	249 – 255
	#2 GREEN (LW)	#2 WHITE (RW)	8'	256 – 264
	#2 GREEN (LW)	#2 RED (RW)	8'	265 – 275
	#2 GOLD (LW)	#2 RED (RW)	8'	276 – 289
	#2 BROWN (LW)	#2 GOLD (RW)	8'	290 – 298
	#2 RED (LW)	#2 BLUE (RW)	8'	299 – 304
	#2 GREEN (LW)	#2 GOLD (RW)	8'	305 – 316
	#2 GOLD (LW)	#2 GOLD (RW)	8'	317 – 327
	#2 GREEN (LW)	#2 BLUE (RW)	8'	328 – 338
	#2 GOLD (LW)	#2 BLUE (RW)	8'	339 – 351
	#2 GREEN (LW)	#5 ORANGE (RW)	8'	352 – 362
	#2 GOLD (LW)	#5 ORANGE (RW)	8'	363 – 385
#2 BLUE (LW)	#5 ORANGE (RW)	8'	386 – 408	
#5 ORANGE (LW)	#5 ORANGE (RW)	8'	409 – 415	
#8 BROWN (LW)	#7 WHITE (RW)	8'	416 – 418	
#3 LT. BLUE (LW)	#7 WHITE (RW)	8'	419 – 423	
#8 WHITE (LW)	#7 WHITE (RW)	8'	424 – 444	
#7 WHITE (LW)	#7 WHITE (RW)	8'	445 – 465	

*Refer to page 2 for door weighing instructions.

OPTION

3 Select by Model and Size of Door

	SPRING (LEFT WOUND)	SPRING (RIGHT WOUND)	4200 BRONZE SERIES	5200 SILVER SERIES	6130 GOLD SERIES
7' TALL DOORS	#2 YELLOW (LW)	—	8' x 7' 9' x 7'	8' x 7' 9' x 7'	
	#1 YELLOW (LW)	—			
	#2 RED (LW)	—			8' x 7'
	#1 WHITE (LW)	—			9' x 7'
	#2 BLUE (LW)	—		16' x 7'	16' x 7'
	#1 WHITE (LW)	#1 ORANGE (RW)			
	#1 YELLOW (LW)	#1 WHITE (RW)			16' x 7'
8' TALL DOORS	#2 RED (LW)	—			
	#2 BROWN (LW)	—			9' x 8'
	#2 BROWN (LW)	#2 YELLOW (RW)			
	#2 RED (LW)	#2 RED (RW)			16' x 8'
	#2 WHITE (LW)	—		9' x 8'	
	#7 ORANGE (LW)	—		16' x 8'	

Torsion springs are special order parts for our retailers.

Important Note
If replacing one spring, replace ALL springs on the door.

EXTENSION SPRINGS

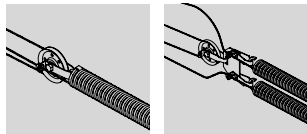

Single (1 Pair) Double (2 Pairs)

Illustrations are of one side of door.

Note: Single (1 Pair) Springs – Spring # (on **one** side of door) equals weight of door.
 Double (2 Pairs) Springs – Spring # for combined springs (on **one** side of door) equals weight of door.

Example: A door weighing 160 lbs. would use:

One (1) 160# (#2 BROWN) spring on **both** sides of door for a total of two (2) 160# springs. – OR –
 Two (2) 80# (#1 GOLD) springs on **both** sides of door for a total of four (4) 80# springs.

OPTION

2 Select by Height and Weight of Door

OPTION

3 Select by Model and Size of Door

7' TALL DOORS

PART NUMBER	SPRING (FIRST PAIR)	SPRING (SECOND PAIR)	DOOR HEIGHT	DOOR WEIGHT (LBS.)*
0140020	#1 RED (50#)	—	7'	46 – 54
0140030	#1 BROWN (60#)	—	7'	55 – 64
0140040	#1 ORANGE (70#)	—	7'	65 – 74
0140050	#1 GOLD (80#)	—	7'	75 – 84
0140060	#1 LT. BLUE (90#)	—	7'	85 – 94
0140070	#1 TAN (100#)	—	7'	95 – 104
0140075	#1 WHITE (110#)	—	7'	105 – 114
0140090	#1 GREEN (120#)	—	7'	115 – 124
0140100	#1 YELLOW (130#)	—	7'	125 – 134
0140110	#1 BLUE (140#)	—	7'	135 – 144
0140210	#2 RED (150#)	—	7'	145 – 154
0140130	#2 BROWN (160#)	—	7'	155 – 164
0140140	#2 ORANGE (170#)	—	7'	165 – 174
0140150	#2 GOLD (180#)	—	7'	175 – 184
0140160	#2 LT. BLUE (190#)	—	7'	185 – 194
0140170	#2 TAN (200#)	—	7'	195 – 204
0140180	#2 WHITE (210#)	—	7'	205 – 214
	#1 WHITE (110#)	#1 WHITE (110#)	7'	215 – 224
	#1 GREEN (120#)	#1 WHITE (110#)	7'	225 – 234
	#1 GREEN (120#)	#1 GREEN (120#)	7'	235 – 244
	#1 YELLOW (130#)	#1 GREEN (120#)	7'	245 – 254
	#1 YELLOW (130#)	#1 YELLOW (130#)	7'	255 – 264
	#1 BLUE (140#)	#1 YELLOW (130#)	7'	265 – 274
	#1 BLUE (140#)	#1 BLUE (140#)	7'	275 – 284
	#1 BLUE (140#)	#2 RED (150#)	7'	285 – 294
	#2 RED (150#)	#2 RED (150#)	7'	295 – 304
	#2 RED (150#)	#2 BROWN (160#)	7'	305 – 314
	#2 BROWN (160#)	#2 BROWN (160#)	7'	315 – 324
	#2 BROWN (160#)	#2 ORANGE (170#)	7'	325 – 334
	#2 ORANGE (170#)	#2 ORANGE (170#)	7'	335 – 344
	#2 ORANGE (170#)	#2 GOLD (180#)	7'	345 – 354
	#2 GOLD (180#)	#2 GOLD (180#)	7'	355 – 364
	#2 GOLD (180#)	#2 LT. BLUE (190#)	7'	365 – 374
	#2 LT. BLUE (190#)	#2 LT. BLUE (190#)	7'	375 – 384
	#2 LT. BLUE (190#)	#2 TAN (200#)	7'	385 – 394
	#2 TAN (200#)	#2 TAN (200#)	7'	395 – 404

REFERENCE PART NUMBERS ABOVE

8' TALL DOORS

5280422	RED (50#)	—	8'	46 – 54
4109909	BROWN (60#)	—	8'	55 – 64
0140200	#3 ORANGE (70#)	—	8'	65 – 74
0140210	GOLD (80#)	—	8'	75 – 84
0140220	#4 LT. BLUE (90#)	—	8'	85 – 94
0140230	#3 TAN (100#)	—	8'	95 – 104
0140235	#4 WHITE (110#)	—	8'	105 – 114
0140240	#3 GREEN (120#)	—	8'	115 – 124
0140250	#2 YELLOW (130#)	—	8'	125 – 134
0140260	#2 BLUE (140#)	—	8'	135 – 144
0140270	#3 RED (150#)	—	8'	145 – 154
0140280	#3 BROWN (160#)	—	8'	155 – 164
0140290	#4 ORANGE (170#)	—	8'	165 – 174
0140300	#4 GOLD (180#)	—	8'	175 – 184
0140310	#3 LT. BLUE (190#)	—	8'	185 – 194
0140320	#4 TAN (200#)	—	8'	195 – 204
0140330	#3 WHITE (210#)	—	8'	205 – 214
	#4 WHITE (110#)	#4 WHITE (110#)	8'	215 – 224
	#4 WHITE (110#)	#3 GREEN (120#)	8'	225 – 234
	#3 GREEN (120#)	#3 GREEN (120#)	8'	235 – 244
	#3 GREEN (120#)	#2 YELLOW (130#)	8'	245 – 254
	#2 YELLOW (130#)	#2 YELLOW (130#)	8'	255 – 264
	#2 YELLOW (130#)	#2 BLUE (140#)	8'	265 – 274
	#2 BLUE (140#)	#2 BLUE (140#)	8'	275 – 284
	#2 BLUE (140#)	#3 RED (150#)	8'	285 – 294
	#3 RED (150#)	#3 RED (150#)	8'	295 – 304
	#3 RED (150#)	#3 BROWN (160#)	8'	305 – 314
	#3 BROWN (160#)	#3 BROWN (160#)	8'	315 – 324
	#3 BROWN (160#)	#4 ORANGE (170#)	8'	325 – 334
	#4 ORANGE (170#)	#4 ORANGE (170#)	8'	335 – 344
	#4 ORANGE (170#)	#4 GOLD (180#)	8'	345 – 354
	#4 GOLD (180#)	#4 GOLD (180#)	8'	355 – 364
	#4 GOLD (180#)	#3 LT. BLUE (190#)	8'	365 – 374
	#3 LT. BLUE (190#)	#3 LT. BLUE (190#)	8'	375 – 384
	#3 LT. BLUE (190#)	#4 TAN (200#)	8'	385 – 394
	#4 TAN (200#)	#4 TAN (200#)	8'	395 – 404

REFERENCE PART NUMBERS ABOVE

7' TALL DOORS

PART NUMBER	SPRING (FIRST PAIR)	SPRING (SECOND PAIR)	4200 BRONZE SERIES	5200 SILVER SERIES	6130 GOLD SERIES
0140050	#1 GOLD (80#)	—	8' x 7'		
0140060	#1 LT. BLUE (90#)	—	9' x 7'	8' x 7' 9' x 7'	
0140070	#1 TAN (100#)	—			
0140075	#1 WHITE (110#)	—			8' x 7'
0140090	#1 GREEN (120#)	—			9' x 7'
0140130	#2 BROWN (160#)	—	16' x 7'		
0140140	#2 ORANGE (170#)	—		16' x 7'	
0140160	#2 LT. BLUE (190#)	—			
0140180	#2 WHITE (210#)	—			16' x 7'

8' TALL DOORS

0140250	#2 YELLOW (130#)	—			
0140260	#2 BLUE (140#)	—			9' x 8'
0140235	#4 WHITE (110#)	#4 WHITE (110#)		9' x 8'	
0140240	#3 GREEN (120#)	#3 GREEN (120#)			16' x 8'
0140310	#3 LT. BLUE (190#)	—		16' x 8'	

INDUSTRY STANDARD COLOR CODES

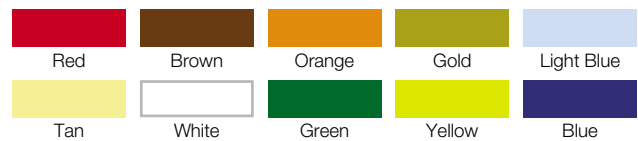

Extension springs are special order parts for our retailers.

Important Note
 If replacing one spring, replace ALL springs on the door.

*Refer to page 2 for door weighing instructions.

SPRING TENSION REMOVAL FOR WEIGHING DOOR



EXTENSION SPRINGS CAN BE VERY DANGEROUS AND MAY CAUSE SERIOUS INJURY OR DEATH IF THEY ARE IMPROPERLY INSTALLED OR MISHANDLED. DO NOT ATTEMPT TO REMOVE THEM YOURSELF UNLESS, 1) YOU HAVE THE PROPER TOOLS AND REASONABLE MECHANICAL APTITUDE OR EXPERIENCE, AND 2) YOU FOLLOW THESE INSTRUCTIONS VERY CAREFULLY. SERIOUS INJURY COULD RESULT IF SPRING TENSION HAS NOT BEEN RELEASED BEFORE OTHER WORK BEGINS.

EXTENSION SPRING

HOW TO REMOVE TENSION FROM REMAINING SPRINGS IN ORDER TO WEIGH DOOR

If the door has two extension springs and only one is broken, always replace both springs. Replacement spring(s) must be identical to each other.

TOOLS NEEDED: (Qty. 2) C-clamps or locking pliers

STEP 1: Disconnect the garage door opener; carefully raise the door to fully open position. Place C-clamps or locking pliers on both sides of the track below the bottom rollers to keep door from falling closed (*Illus. 1*).

STEP 2: With the door in the fully open position the tension will be removed from the springs and the lift cable can be removed from the garage door bottom bracket button (*Illus. 2*). If your door is equipped with a safety containment cable, this also must be removed at this time from the track assembly (*Illus. 3*).

STEP 3: Wood blocks should be placed under the door before closing to prevent finger from being trapped.

STEP 4: Remove the C-clamps from the track and carefully close the door.

WARNING

USE TWO OR MORE HELPERS TO ASSIST YOU IN LOWERING THE DOOR. SOME LARGE DOORS MIGHT WEIGH AS MUCH AS 500 POUNDS

WHEN THE SPRING TENSION IS REMOVED. THE WEIGHT OF THE DOOR WILL NOT BE APPARENT WHEN YOU FIRST BEGIN TO CLOSE THE DOOR. THE DOOR WILL FEEL PROGRESSIVELY HEAVIER AS IT IS LOWERED UNTIL ITS FULL WEIGHT IS REALIZED ABOUT ONE FOOT FROM THE FLOOR. TO AVOID INJURY, KEEP HANDS AND FINGERS CLEAR OF SECTION JOINTS, TRACK AND OTHER DOOR PARTS WHILE THE DOOR IS CLOSING.

STEP 5: Proceed to weigh the door.

Illus. 1

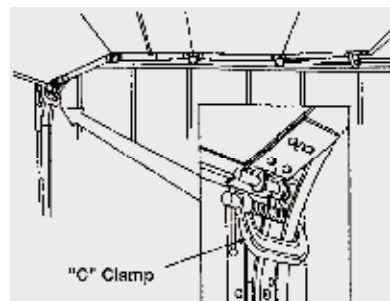

Illus. 2

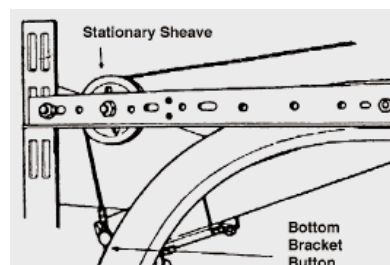

Illus. 3

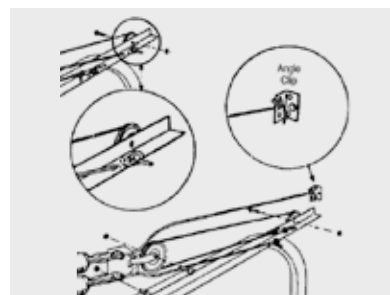

SPRING TENSION REMOVAL FOR WEIGHING DOOR



TORSION SPRINGS CAN BE VERY DANGEROUS AND MAY CAUSE SERIOUS INJURY OR DEATH IF THEY ARE IMPROPERLY INSTALLED OR MISHANDLED. DO NOT ATTEMPT TO INSTALL THEM YOURSELF UNLESS, 1) YOU HAVE THE PROPER TOOLS AND REASONABLE MECHANICAL APTITUDE OR EXPERIENCE, AND 2) YOU FOLLOW THESE INSTRUCTIONS VERY CAREFULLY.

EZ-SET® TORSION SPRING

HOW TO REMOVE TENSION FROM REMAINING SPRINGS IN ORDER TO WEIGH DOOR

These instructions apply only for the purpose of removing tension from residential EZ-SET® torsion spring configurations with standard radius (springs mounted to the front header of the garage). If the door has two EZ-SET® torsion springs and only one is broken, always replace both springs.

TOOLS NEEDED: 3/8" medium-duty reversible drill
1/4" insert bit or 7/16" socket wrench
C-clamp or locking pliers

STEP 1: Disconnect the garage door opener, lock the door securely in the DOWN position using the door lock, C-clamp or locking pliers placed directly above a roller. This must be done to prevent the door from prematurely opening which could cause injury.

STEP 2: If the door has only one spring and it is broken, proceed to weigh door.

STEP 3: If there are two springs, the remaining unbroken spring must be unwound and replaced. Remove all tension COMPLETELY from the torsion spring. DO NOT loosen any set screws on the spring winding cones. Insert the 1/4" insert bit in the drill and engage the bit or 7/16" socket wrench on the drive shaft of the winding unit and rotate the drive shaft counterclockwise to remove tension from the spring (*Illus. 1*).

NOTE: High drill RPMs may cause lubricant to come out of the winding unit. All tension in the spring is removed when the line (or description) on the spring is in a straight line. There should be no tension on the torsion cables, and shaft should rotate freely. Proceed to weigh the door.



SPRING TENSION REMOVAL FOR WEIGHING DOOR



TORSION SPRINGS CAN BE VERY DANGEROUS AND MAY CAUSE SERIOUS INJURY OR DEATH IF THEY ARE IMPROPERLY INSTALLED OR MISHANDLED. DO NOT ATTEMPT TO INSTALL THEM YOURSELF UNLESS, 1) YOU HAVE THE PROPER TOOLS, REASONABLE MECHANICAL APTITUDE AND EXPERIENCE, AND UPPER ARM STRENGTH, AND 2) YOU FOLLOW THESE INSTRUCTIONS VERY CAREFULLY. PROFESSIONAL INSTALLATION IS RECOMMENDED. DO NOT ATTEMPT TO REMOVE TORSION SPRING TENSION IF THE WOOD MOUNTING PAD CONNECTING THE BRACKET TO THE CENTER OF THE SPRINGS IS SPLIT OR ROTTED, OR IF THE FASTENERS AT THIS POINT ARE LOOSE OR MISSING.

TORSION SPRING

HOW TO REMOVE TENSION FROM REMAINING SPRINGS IN ORDER TO WEIGH DOOR

These instructions apply only for the purpose of removing tension from torsion springs (springs mounted to the front header of the garage). Use only torsion spring winding bars for removing and adjusting standard torsion spring(s). **DO NOT USE ANY OTHER TYPE OF TOOL FOR WINDING OR UNWINDING STANDARD TORSION SPRING(S).** If the door has two torsion springs and only one is broken, always replace both springs.

TOOLS NEEDED: Adjustable wrench or 3/8" open end wrench
C-clamp or locking pliers
1/2" x 18" cold rolled steel winding bars part number 5686901 (available for purchase when the spring is special ordered)

STEP 1: Disconnect the garage door opener; lock the door securely in the down position using the door lock, C-clamp or locking pliers placed directly above a roller. This must be done to prevent the door from prematurely opening which could cause injury.

STEP 2: If the door has only one spring and it is broken, proceed to weigh door. If there are two springs, the remaining unbroken spring must be unwound and replaced. Proceed with Steps 3 through 6.

STEP 3: Remove all tension COMPLETELY from remaining torsion spring. Use a sturdy ladder and stand to the side of the winding bars and insert one winding bar as shown in Illus. 1. Winding bars MUST always be inserted the full depth of the holes in the winding cone and supported (be prepared to handle a large force) before any set screws on the spring winding cones are loosened. Positioning your hand near the end of the winding bar, push up on the winding bar to allow the second winding bar to be inserted, then slowly allow the second winding bar to rest against the back of the door, as shown in Illus. 2. Watch out that your fingers do not get pinched between the winding bar and back of the door or that the winding bar does not hit any window glass in the top section. If you cannot push the first winding bar up or feel uncomfortable with the force on the bar, stop, and contact a qualified door service professional.

STEP 4: Loosen the two set screws on the spring winding cone while firmly holding the lower winding bar and making sure that the lower winding bar is against the back of the door. When set screws are loose, full spring tension will be on the lower winding bar (Illus. 3).

STEP 5: Push up on the upper winding bar slightly and remove the lower winding bar while holding tight on the upper winding bar. Allow the spring and upper winding bar to slowly rotate downward so that the upper bar rests against the back of the door. This decreases the tension on the spring in 1/4 turn increments (Illus. 4).

STEP 6: Repeat this process of inserting a winding bar fully in the upper hole position, push up slightly, removing the lower winding bar and letting the tension slowly rotate the winding bar until it rests against the back of the door. Repeat this process until all tension is removed from the torsion spring. There should be no tension on the cables, and the shaft should rotate freely. Proceed to weigh the door.



Illus. 1

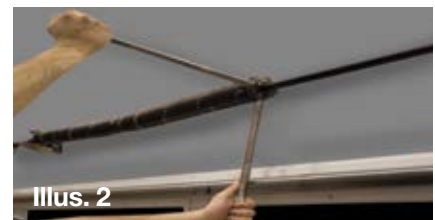

Illus. 2



Illus. 3

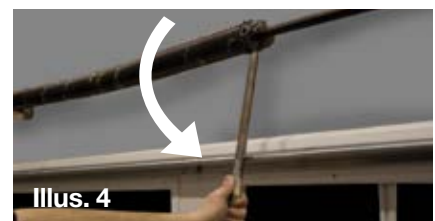

Illus. 4

